

F18 Configuration and Accessories

Mold injection Connector (IP68 Factory Assembly Only)

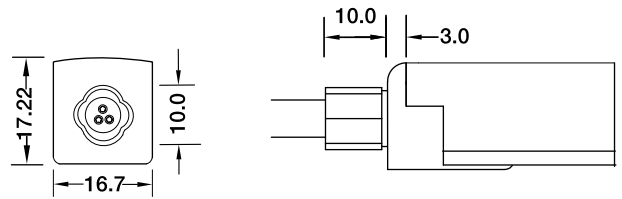

Direct Entry Connector
MJ-18-D3-D02SM
MJ-18-D3-D03SFM



Side Entry Connector
MJ-18-D3-S02SM
MJ-18-D3-S03SFM

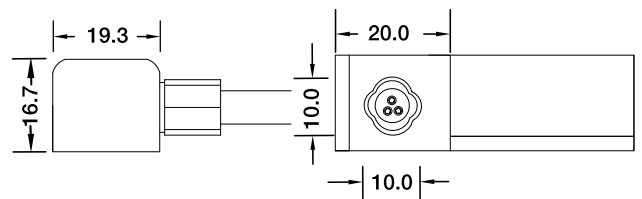

Bottom Entry Connector
MJ-18-D3-B02SM
MJ-18-D3-B03SFM

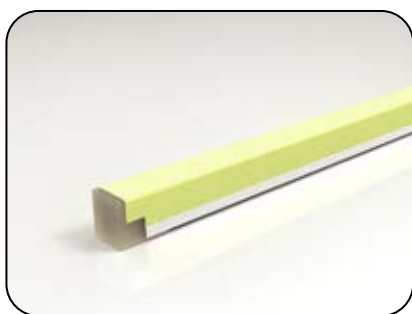
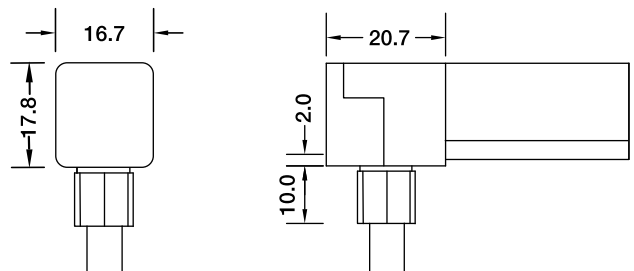

End Cap

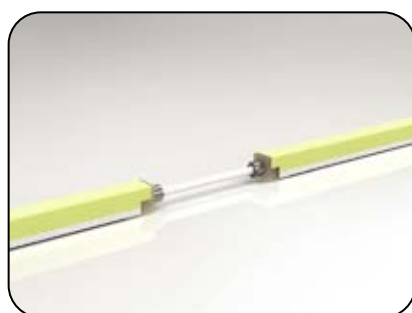
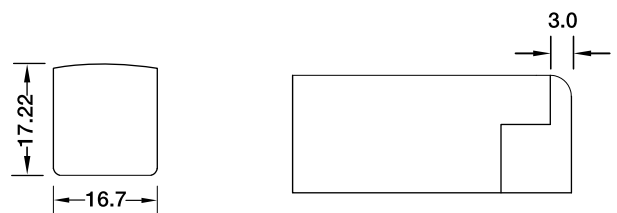

Jumper
MJ-18-D3-D-JC

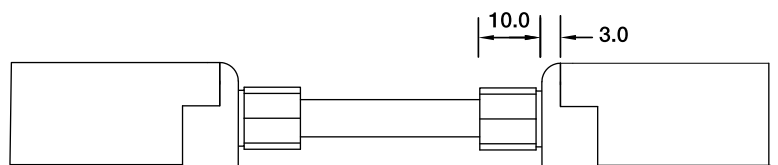

F18 Configuration and Accessories

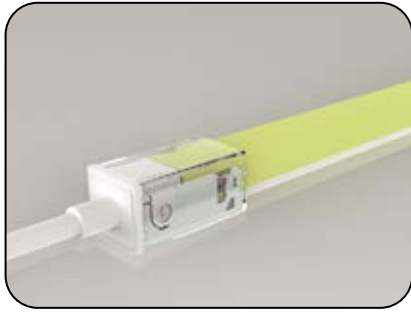

DIY Snap Connector
DIY-SN-FR-16-D-01SF/02SM-D3

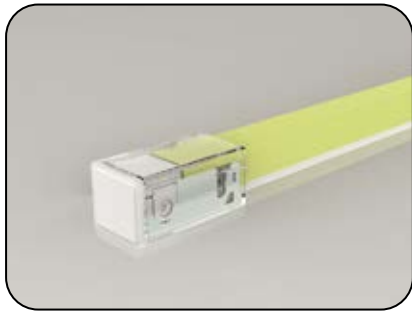
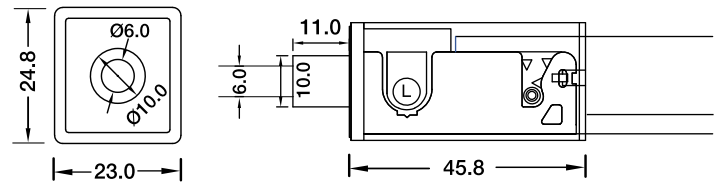

DIY Snap End Cap
DIY-SN-END-16-D-01/02

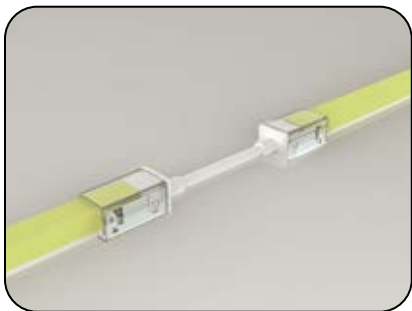
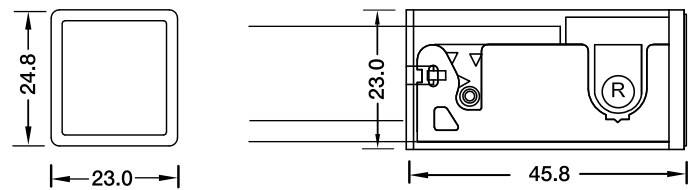

DIY Snap Connector Jumper
DIY-SN-FR-16-D6-D-JC

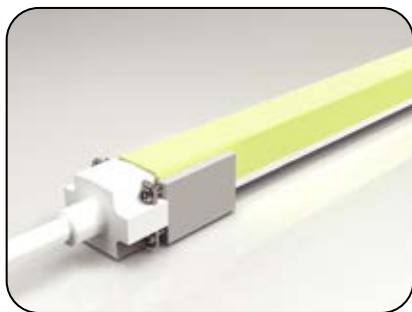
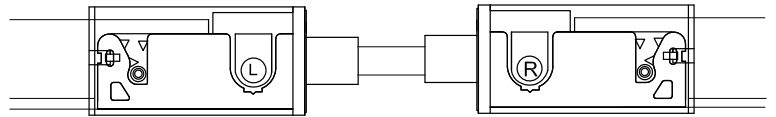

DIY Screw Connector
DIY-SC-FR-16-D-01SF/02SM-D3

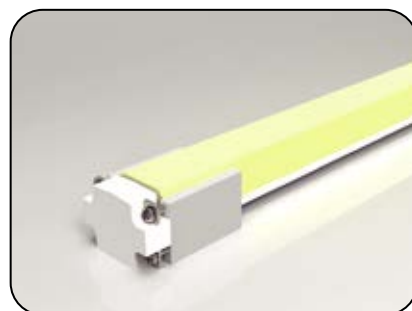
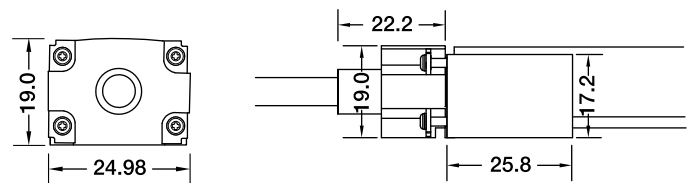

DIY Screw Connector
DIY-SC-END-16

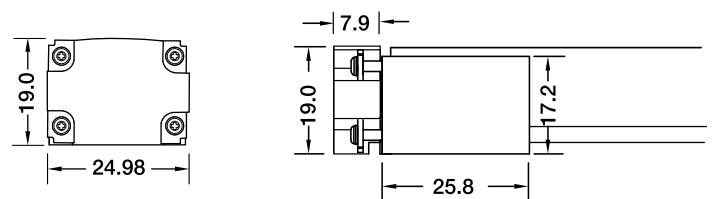

F18 Configuration and Accessories

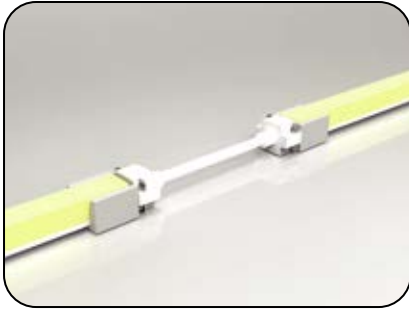

DIY Screw Extension Connector
DIY-SC-EXT-16-D3

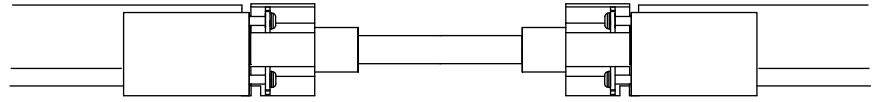

Waterproof Interrupter

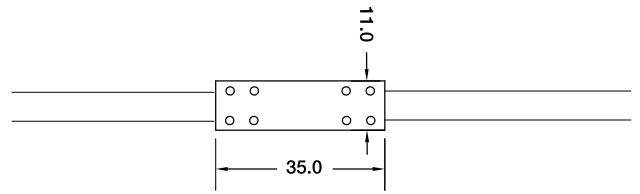

Male Connector
SYZ-M12-M-3C-05-W

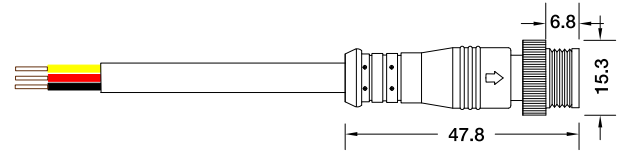

Female Connector
SYZ-M12-F-3C-05-W

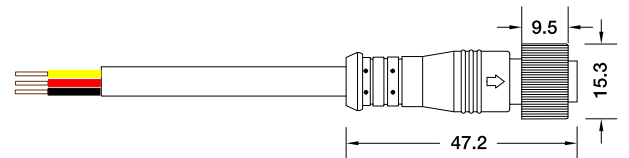

LED Linear Flex Mounting Channel

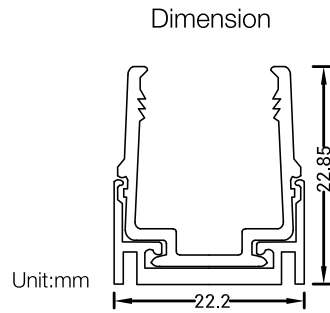

Installation Way

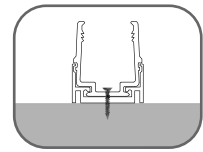

Surface Mounted

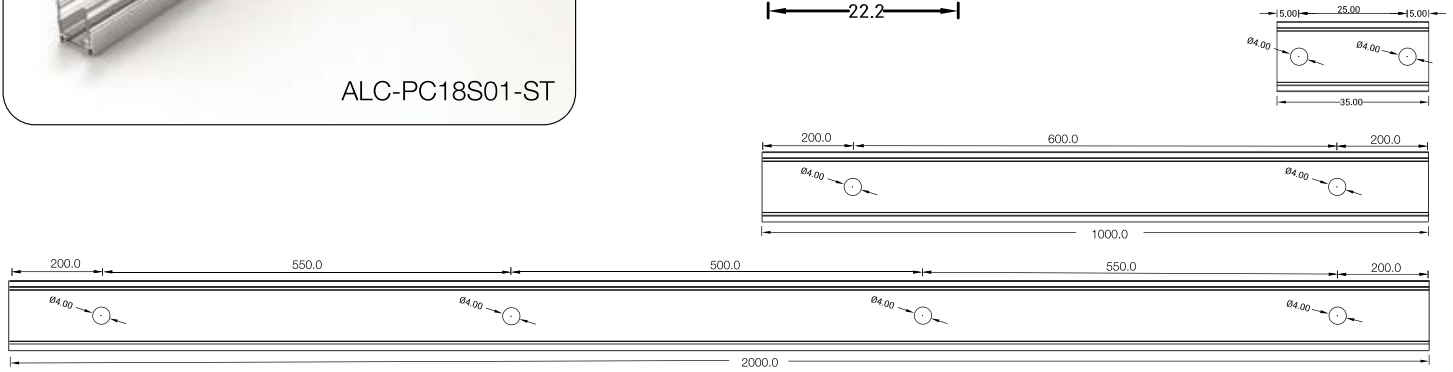

Model	W x H(mm)	Standard Length	Screw Holes	Holes Numbers	Suitable Product
ALC-PC18S01-ST-035	22.2*22.85	35mm	Φ4.0mm	2	F18, SF18
ALC-PC18S01-ST-100		1000mm	Φ4.0mm	2	F18, SF18
ALC-PC18S01-ST-200		2000mm	Φ4.0mm	4	F18, SF18

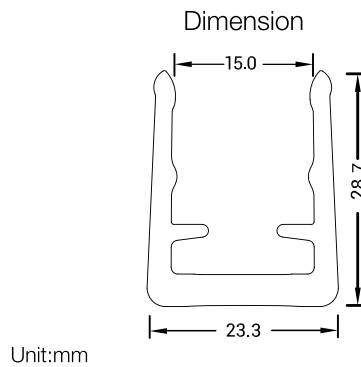

Installation Way

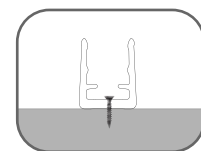

Surface Mounted

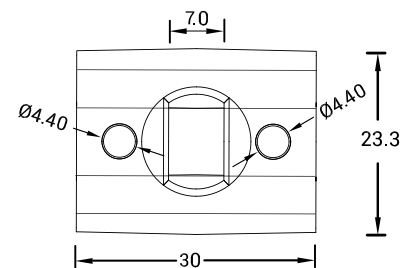

Model	W x H(mm)	Standard Length	Screw Holes	Holes Numbers	Suitable Product
SJJ-ZSH-008-PC	23.3*28.7	30mm	Φ4.40mm	2	F18, SF18