

F18 Configuration and Accessories

Mold Injection Connector (IP68 Factory Assembly Only)

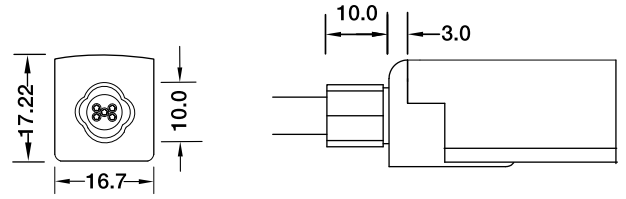

Direct Entry Connector
MJ-18-D5-D02SM
MJ-18-D5-D03SFM



Side Entry Connector
MJ-18-D5-S02SM
MJ-18-D5-S03SFM

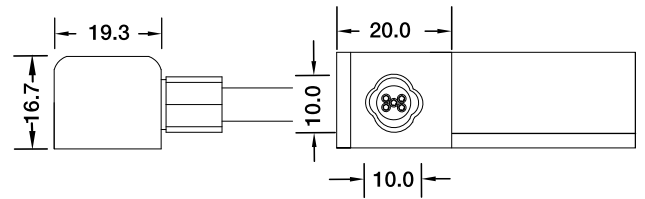

Bottom Entry Connector
MJ-18-D5-B02SM
MJ-18-D5-B03SFM

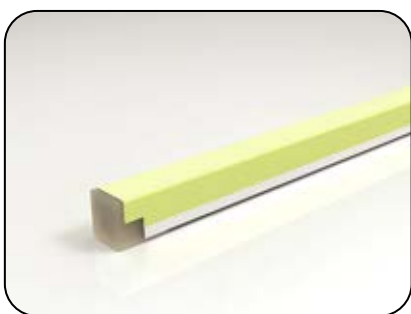
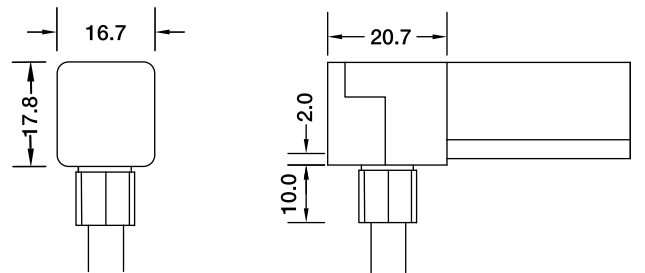

End Cap

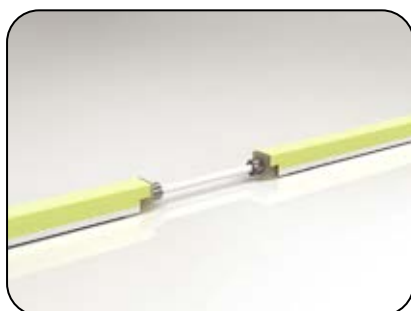
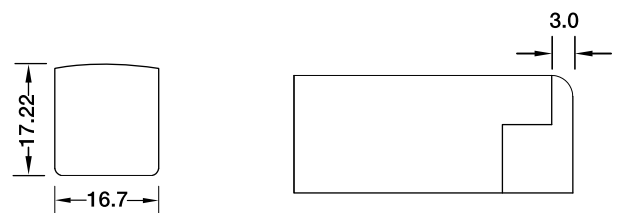

Jumper
MJ-18-D5-D-JC

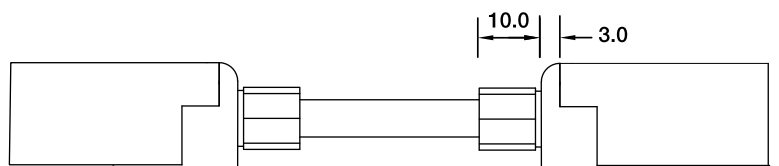

F18 Configuration and Accessories



Waterproof Interrupter

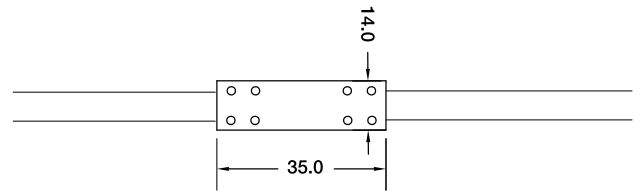

Male Connector
SYZ-M12-M-5C-05-W

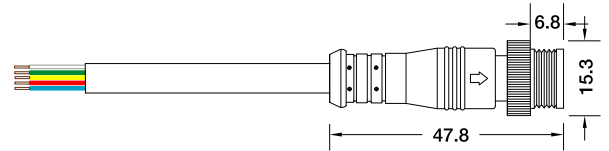

Female Connector
SYZ-M12-F-5C-05-W

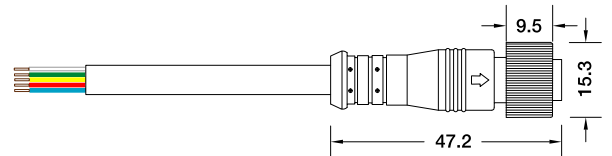

LED Linear Flex Mounting Channel



Dimension

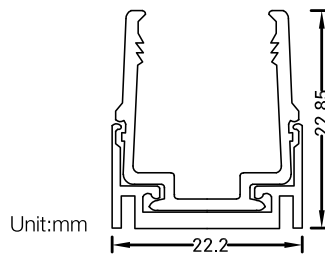

Installation Way

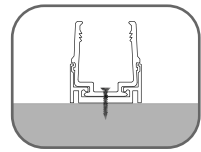

Surface Mounted

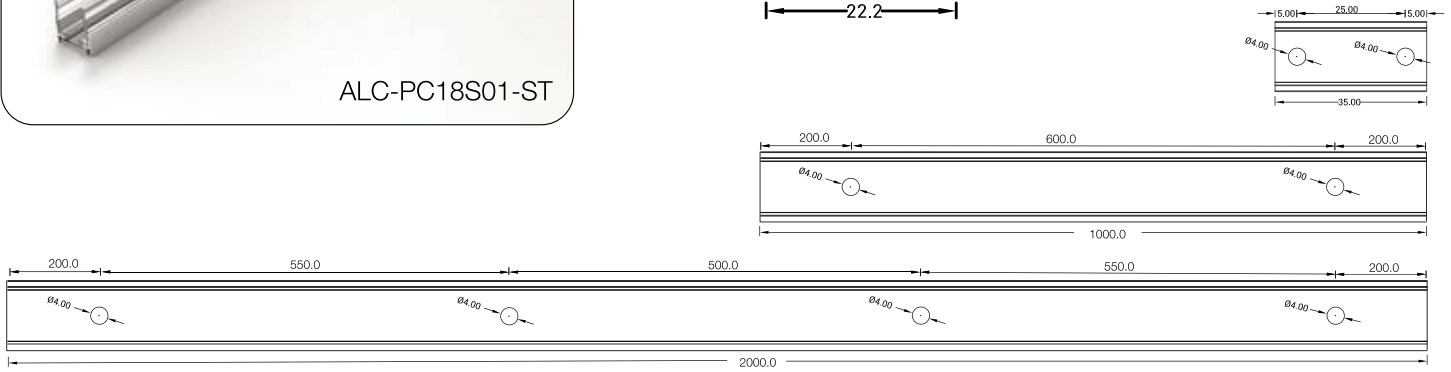

Model	W x H(mm)	Standard Length	Screw Holes	Holes Numbers	Suitable Product
ALC-PC18S01-ST-035	22.2*22.85	35mm	Φ4.0mm	2	F18, SF18
ALC-PC18S01-ST-100		1000mm	Φ4.0mm	2	F18, SF18
ALC-PC18S01-ST-200		2000mm	Φ4.0mm	4	F18, SF18



Dimension

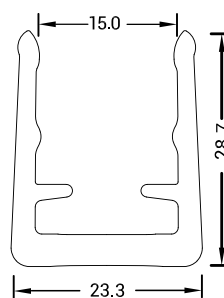

Installation Way

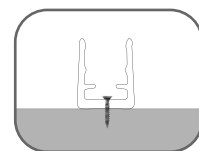

Surface Mounted

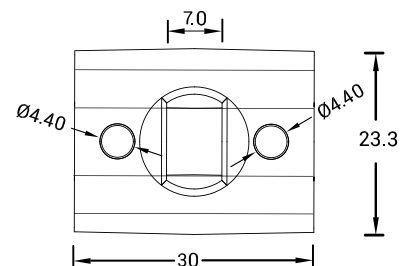

Model	W x H(mm)	Standard Length	Screw Holes	Holes Numbers	Suitable Product
SJJ-ZSH-008-PC	23.3*28.7	30mm	Φ4.40mm	2	F18, SF18

LED linear Flex Packing Details



Standard: Carton (Paper Reel Inside)

Product	Max.Length	Carton Size	Net Weight	Gross Weight
F15/SF15	30m	34*34*18cm	12kg	13.6kg
F16/SF16	20m	34*34*18cm	8.6kg	10.2kg
F17/SF17	20m	34*34*18cm	8.6kg	10.2kg
F18/SF18	20m	34*34*18cm	8.6kg	10.2kg
F21/SF21	20m	34*34*18cm	10.4kg	12.0kg
F10/SF10	30m	34*34*18cm	9.6kg	11.2kg
F09/SF09	35m	34*34*18cm	5.8kg	7.4kg
F08/SF08	30m	34*34*18cm	7.2kg	8.8kg
F06/SF06	30m	34*34*18cm	7.2kg	8.8kg



Custom: Carton (White Box+ Plastic Plate Inside)

Product	Package 1 Dimension	Length	Gross Weight	Package 2 Dimension	Length	Gross Weight
F15/SF15	38*38*3cm	5m	2.5kg	45*55*3cm	10m	5kg
F16/SF16	38*38*3cm	5m	2.6kg	51*61*4cm	10m	5.2kg
F17/SF17	38*38*3cm	5m	2.6kg	51*61*4cm	10m	5.2kg
F18/SF18	38*38*3cm	5m	2.6kg	51*61*4cm	10m	5.2kg
F21/SF21	38*38*3cm	5m	3.1kg	51*61*4cm	10m	6.2kg
F10/SF10	38*38*3cm	5m	2.0kg	45*55*3cm	10m	4kg
F09/SF09	38*38*3cm	5m	1.5kg	45*55*3cm	10m	3kg
F08/SF08	38*38*3cm	5m	1.5kg	45*55*3cm	10m	3kg
F06/SF06	38*38*3cm	5m	1.5kg	45*55*3cm	10m	3kg